



DM



YM



NAME: LED Shoebox Light

Note: The Letter Z in P/N stands for

AM: ADJUSTABLE FITTER MOUNTING

DM: DIRECT MOUNTING

YM: YOKE MOUNTING

Advantage:

- UL cUL DLC certificate
- PHILIPS LUMILEDS Chip, high CRI
- Mean Well IP65 driver, input voltage 100-277VAC
- No UV or IR in the beam
- Easy to install and operate
- Energy saving, long lifespan
- Light is soft and uniform, safe to eyes
- Instant start, NO flickering, NO humming
- Green and eco-friendly without mercury.

Application:

- 1. Outdoor basketball court, tennis court.
- 2. Badminton court, the football field.
- 3. The school playground, stadium.
- 4. Community leisure entertainment plaza, road lamp etc.

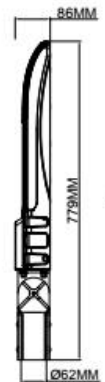
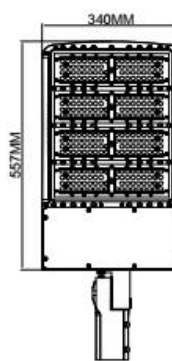

AM

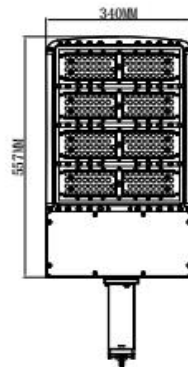

DM

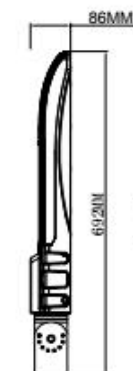
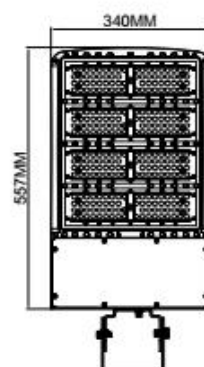

YM

TECHNICAL DATA SHEET

Product Specifications

Product name	LED Shoebox Light		
Light Type	Shoebox Light		
Dimension	779*340*86mm	748*340*100mm	692*340*86mm

Technical Characteristic

Color temperature	3000K	3500K	4000K	5000K	5700K
CRI	>70				
Lumen	36000-41000LM				
Lumen Efficacy	120-135 LM/W				
Input Power	300W				
Viewing Angle	150*85 Degree (Type III)				
Input Voltage	100-277V 50/60Hz				
Driver model	HLG-320H-48B (1-10Vdc Dimmer)				
PFC	>0.9				
Waterproof Rating	IP65				

Materials

LED Brand	PHILIPS LUMILEDS
LED Type	LUXEON 3030 2D (1.5W)
LED QTY	280PCS
Housing	Aluminum Alloy
Housing color	Black
Optional Accessory	Photocell / Surge protector / Motion sensor
Operating Temperature	-20℃ TO 45℃
Operating Humidity	20%-90% RH
Storage Temperature	-30℃ TO 80℃

Others

Storage Humidity	10%-95%
Application	Outdoor
Safety Certification	UL、cUL、DLC
Warranty Time	5 Years

TECHNICAL DATA SHEET

Light Distribution Testing Parameters

DATA OF LAMP		PHOTOMETRIC DATA Eff: 127.95 lm/W			
		I _{max} (cd)	18382	S/MH (C0/180)	1.63
NOMINAL POWER (W)	300	LOR (%)	100.0	S/MH (C90/270)	0.74
RATED VOLTAGE (V)	120	TOTAL FLUX (lm)	39390	η UP, DN (C0-180)	0.1, 67.3
NOMINAL FLUX (lm)	39390.4	CIE CLASS	DIRECT	η UP, DN (C180-360)	0.1, 32.5
LAMPS INSIDE	1	η up (%)	0.2	CIBSE SHR NOM	1.25
TEST VOLTAGE (V)	120.0	η down (%)	99.8	CIBSE SHR MAX	1.35

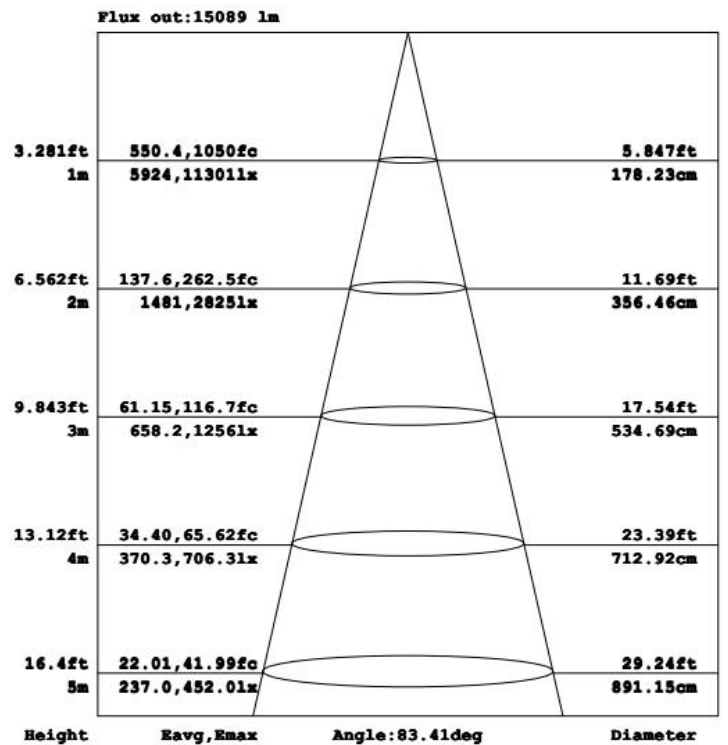
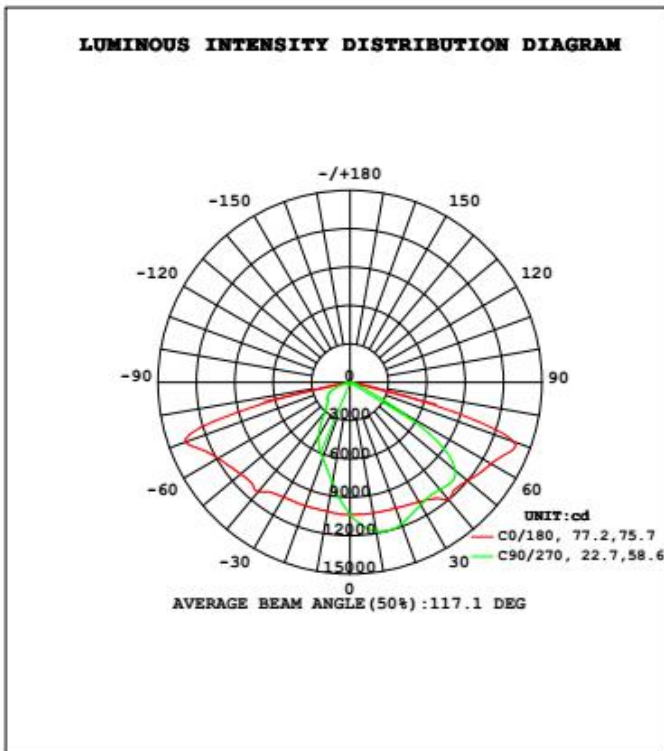

Note: The Curves indicate the illuminated area and the average illumination when the luminaire is at different distance.

Package

Lamp Net Weight: 11.3 KG/PC

	Size	Qty/Carton	Weight/Carton
Outer box	820*390*145 MM	1	12.0 KG

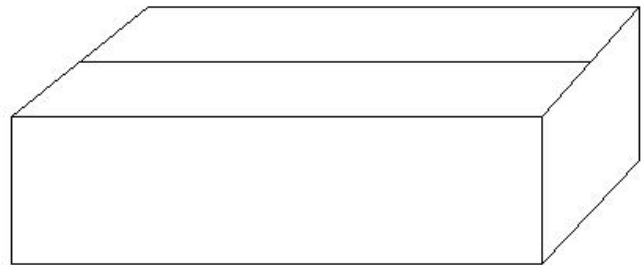
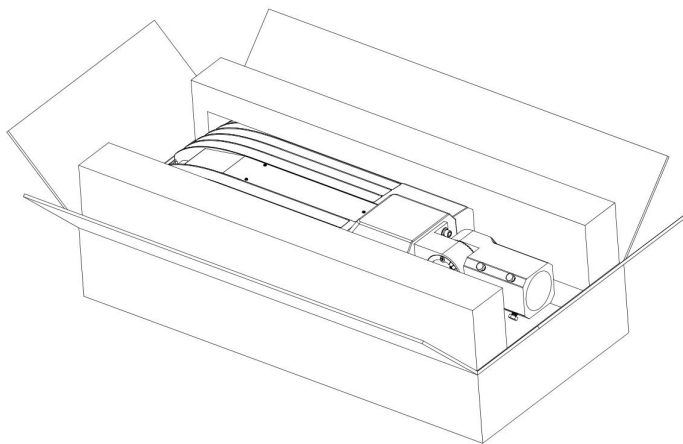

Notice For User

- ◆ Please turn off power before install or change assembly parts.
- ◆ The input voltage and lamps should be matched, after connecting the power line, Please make sure the wiring section is insulated.
- ◆ No-professionals, must not install and disassemble the lamps.

Trouble Shootings

Troubles	Check points
Flickering of the light	Turn off the power and turn on again in 3 minutes. If same phenomena occur, then call agencies
Out of working	Please check the connection